

PLASTIC BUCKLE BROCHURE



ITW Fastex General Products

2 - 4 Eskay Road, South Oakleigh, Victoria, 3167, Australia

PO Box 172, Oakleigh MDC, Victoria, 3166, Australia

Telephone: (+61) 03 9570 2566 Fax: (+61) 03 9570 2780

E-mail: customer.service@fastex.com.au



ITW Fastex General Products

2 – 4 Eskay Rd, South Oakleigh Vic. 3167, Australia
 P.O. Box 172, Oakleigh MDC Vic. 3166, Australia
 Telephone: (+61) 03 9570 2566 Fax: (+61) 03 9570 2780
 E-mail: customer.service@fastex.com.au

DISTRIBUTOR LISTING

VICTORIA	Shann Accessories 2/23 Bell Street, Preston Tel: (03) 8480-0800 Fax: (03) 8480-0829
	Paskal Australia 3 Shearson Crescent, Mentone Tel: (03) 9585-1207 Fax: (03) 9583-1699
	Radins Australia 7 Conifer Crescent, Dingley Village Tel: (03) 9551-6000 Fax: (03) 9551-6999
	DDC Australia (Khaki & Black) 35 Korong Street, Heidelberg West Tel: (03) 9459-7877 Fax: (03) 9459-5777
NEW SOUTH WALES	Shann Accessories 31 Toohey Road, Wetherill Park Tel: (02) 9756-2466 Fax: (02) 9756-2270
	Davro Assembly Products 2/66 Clapham Road, Sefton Tel: (02) 9644-4777 Fax: (02) 9645-4187
	Atlas Wholesale Unit 24/8 Victoria Avenue, Castle Hill Tel: (02) 9894-1899 Fax: (02) 9894-1811
QUEENSLAND	Shann Accessories 1/223-225 Ewing Road, Woodridge Tel: (07) 3808-7277 Fax: (07) 3808-2780
SOUTH AUSTRALIA	Shann Accessories 14-20 Conmurra Avenue, Edwardstown Tel: (08) 8277-7733 Fax: (08) 8277-7633
WESTERN AUSTRALIA	Shann / Parkinson & Mann 51 King Edward Road, Osborne Park Tel: (08) 9244-4433 Fax: (08) 9446-8989



ITW Fastex General Products

2 – 4 Eskay Rd, South Oakleigh Vic. 3167, Australia

P.O. Box 172, Oakleigh MDC Vic. 3166, Australia

Telephone: (+61) 03 9570 2566 Fax: (+61) 03 9570 2780

E-mail: customer.service@fastex.com.au

TROVATO SIDE RELEASE

The "Trovato" range is our premium range side release buckles that have been engineered to provide maximum strength and performance. Complimenting this is the stylish design and high quality surface finish making the "Trovato" series both extremely pleasing to the eye as well as ideal for side release applications.



19 mm

25 mm

38 mm

50 mm



50 mm
Dual Ladderloc



ITW New Zealand	ITW FASTEX Australia	Webbing Size	Material	Colour	Description	Type
NZ	950-1142	20mm / ¾"	Acetal	Black	Trovato	SR Single
NZ	950-1135	25mm / 1"	Acetal	Black	Trovato	SR Single
NZ	950-1115	40mm / 1½"	Acetal	Black	Trovato	SR Single
NZ	950-1113	50mm / 2"	Acetal	Black	Trovato	SR Single
NZ	950-1099	50mm / 2"	Acetal	Black	Trovato	DLL Dual

These buckles are also available in Nylon but Minimum Order Quantities may apply



ITW Fastex General Products

2 – 4 Eskay Rd, South Oakleigh Vic. 3167, Australia

P.O. Box 172, Oakleigh MDC Vic. 3166, Australia

Telephone: (+61) 03 9570 2566 Fax: (+61) 03 9570 2780

E-mail: customer.service@fastex.com.au

WORLD SIDE RELEASE

Manufactured by ITW NEXUS, the World Side Release buckle offers many structural and aesthetic features not found in other side release buckles. The addition of a centre support rib for crush resistance, and a reduction in overall length of the buckle, are just a few of the many features of the WSR. Both 40mm and 50mm versions have a contoured profile to improve user comfort.

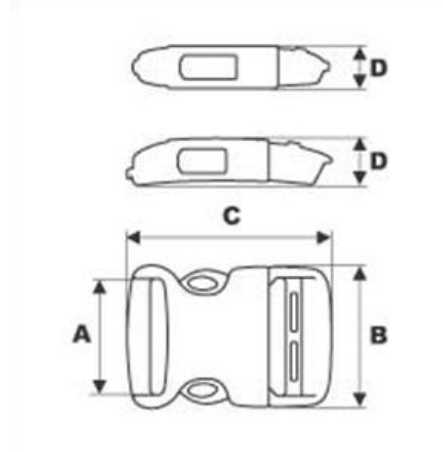

ITW Global	ITW FASTEX Australia	Webbing Size	Material	Colour	A	B	C	D
520-1100 Latch 520-0000 Body	386-1220 386-1221	20mm / ¾"	Acetal	Black	20.4	26.0	47.8	9.5
525-1100 Latch 525-0000 Body	386-1225 386-1226	25mm / 1"	Acetal	Black	26.0	33.0	55.0	12.0
540-1100 Latch 540-0000 Body	386-1240 386-1241	40mm / 1½"	Acetal	Black	39.5	46.5	68.7	14.5
550-1100 Latch 550-0000 Body	386-1250 386-1251	50mm / 2"	Acetal	Black	51.3	58.5	77.5	18.0

They also are available in the DUAL Version.



These buckles are also available in Nylon but Minimum Order Quantities may apply.



ITW Fastex General Products

2 – 4 Eskay Rd, South Oakleigh Vic. 3167, Australia

P.O. Box 172, Oakleigh MDC Vic. 3166, Australia

Telephone: (+61) 03 9570 2566 Fax: (+61) 03 9570 2780

E-mail: customer.service@fastex.com.au

AIRLOC SIDE RELEASE

The Airloc Side Release Buckle series offers many structural and aesthetic features not found in other side release buckles. The addition of a centre support rib for crush resistance, a reduction in overall length of the buckle, and a design which allows the beauty of your application to show through, are just a few of the many features of Airloc buckles.

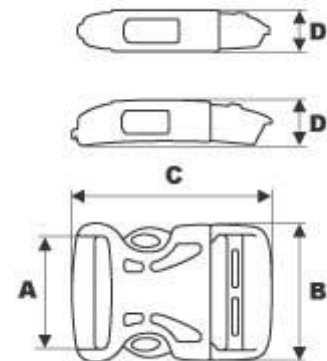

ITW Global	ITW FASTEX Australia	Webbing Size	Material	Colour	A	B	C	D
520-1100 Latch 520-2000 Body	386-1020 386-1021	20mm / ¾"	Nylon	Black	20.4	26.0	47.8	9.5
525-1100 Latch 525-2000 Body	386-1025 386-1026	25mm / 1"	Nylon	Black	26.0	33.0	55.0	12.0
540-1100 Latch 540-2000 Body	386-1040 386-1041	40mm / 1½"	Nylon	Black	39.5	46.5	68.7	14.5
550-1100 Latch 550-2000 Body	386-1050 386-1051	50mm / 2"	Nylon	Black	51.3	58.5	77.5	18.0

They also are available in the DUAL Version.



These buckles are also available in Acetal but Minimum Order Quantities may apply.



ITW Fastex General Products

2 – 4 Eskay Rd, South Oakleigh Vic. 3167, Australia

P.O. Box 172, Oakleigh MDC Vic. 3166, Australia

Telephone: (+61) 03 9570 2566 Fax: (+61) 03 9570 2780

E-mail: customer.service@fastex.com.au

CLASSIC SIDE RELEASE

The "Classic" style of side release buckle has stood the test of time. Meticulously engineered to provide superior strength the "Classic" style buckle is still the preferred shape used by the Australian Defence Force and a number of semi-military or government style organisations.

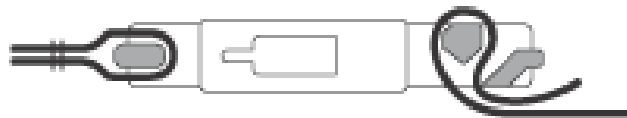

ITW New Zealand	ITW FASTEX Australia	Webbing Size	Material	Colour	Description	Type
NZ	380-0004	25mm / 1"	Acetal	Black	Classic	SR Single
NZ	380-0044	50mm / 2"	Acetal	Black	Classic	SR Single

These buckles are also available in Nylon but Minimum Order Quantities may apply.



ITW Fastex General Products

2 – 4 Eskay Rd, South Oakleigh Vic. 3167, Australia

P.O. Box 172, Oakleigh MDC Vic. 3166, Australia

Telephone: (+61) 03 9570 2566 Fax: (+61) 03 9570 2780

E-mail: customer.service@fastex.com.au

CAMLOC

Camloc Buckles provide an easy-to-use and easy-to-adjust means of securing webbing. The locking doors trap the webbing to prevent unintentional slippage. The "robust" design and glass filled nylon material used for manufacture of the 50mm Camloc buckle, ensures maximum performance when securing webbing.



580-0011



380-1086

ITW Global	ITW FASTEX Australia	Webbing Size	Material	Colour	Description	Type
OS	580-0011	25mm / 1"	Acetal	Black	Camloc	
NZ	380-1086	50mm / 2"	Nylon	Black	Camloc	High Performance



ITW Fastex General Products

2 – 4 Eskay Rd, South Oakleigh Vic. 3167, Australia

P.O. Box 172, Oakleigh MDC Vic. 3166, Australia

Telephone: (+61) 03 9570 2566 Fax: (+61) 03 9570 2780

E-mail: customer.service@fastex.com.au

MAKO TRI-GLIDES

Manufactured by ITW Nexus, the Tri-Glide strap adjuster provides length adjustment on strap assemblies. The Tri-Glides grip webbing securely and work well in combination with other buckles as a means of securing loose webbing. The Tri-Glides are available in many sizes and styles to accommodate an assortment of webbing widths and thicknesses.

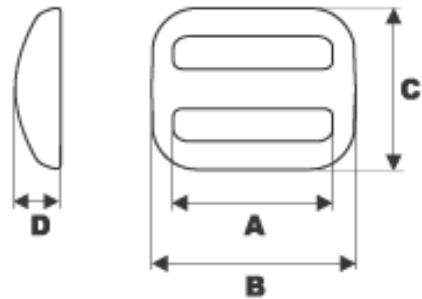

ITW Global	ITW FASTEX Australia	Webbing Size	Material	Colour	A	B	C	D
105-2020	386-0921	20mm / 3/4"	Acetal	Black	20.3	27.9	20.8	5.8
105-2025	386-0926	25mm / 1"	Acetal	Black	25.8	33.3	20.8	5.9
105-2040	386-0941	40mm / 1 1/2"	Acetal	Black	38.9	48.9	34.0	8.2
105-2050	386-0950	50mm / 2"	Acetal	Black	51.6	61.6	34.5	8.2



ITW Fastex General Products

2 – 4 Eskay Rd, South Oakleigh Vic. 3167, Australia

P.O. Box 172, Oakleigh MDC Vic. 3166, Australia

Telephone: (+61) 03 9570 2566 Fax: (+61) 03 9570 2780

E-mail: customer.service@fastex.com.au

TROVATO DOUBLE BAR LADDERLOC

This Ladderloc is designed with an optimum release angle to maximize webbing grip while maintaining easy tightening and gradual release. The unique finger access crown eases release while the part hugs the webbing.

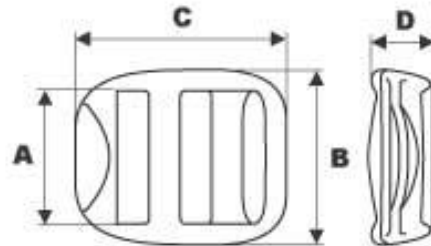

ITW Global	ITW FASTEX Australia	Webbing Size	Material	Colour	A	B	C	D
154-0075	386-1422	20mm / ¾"	Acetal	Black	19.1	26.2	38.0	8.6
154-3100	386-1424	25mm / 1"	Acetal	Black	25.1	32.8	39.8	9.6
154-3150	386-1429	40mm / 1½"	Acetal	Black	38.0	45.5	45.5	10.0

SUPER LADDERLOC

ITW New Zealand	ITW FASTEX Australia	Webbing Size	Material	Colour
NZ	956-1109	25mm / 1"	Acetal	Black





ITW Fastex General Products

2 – 4 Eskay Rd, South Oakleigh Vic. 3167, Australia

P.O. Box 172, Oakleigh MDC Vic. 3166, Australia

Telephone: (+61) 03 9570 2566 Fax: (+61) 03 9570 2780

E-mail: customer.service@fastex.com.au

MAKO SINGLE BAR LADDERLOC

Offers enhanced performance under higher load applications. The Mako Ladderloc family has external styling that affords much easier finger tab access, from the front as well as from either side of the part. This finger tab access increases the ease of release for the end-user. The Mako Ladderloc family is our shortest and lightest Ladderloc due to the elimination of the rear webbing bar.

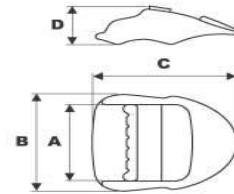

ITW Global	ITW FASTEX Australia	Webbing Size	Material	Colour	A	B	C	D
154-2020	386-1421	20mm / ¾"	Acetal	Black	20.0	26.6	34.0	10.0
154-2025	386-1426	25mm / 1"	Acetal	Black	25.5	32.2	37.7	11.4

JLL Single Ladderloc

The JLL (Jet Ladderloc) utilizes "Hugger" Ladderloc tabs for comfort during web adjustment and families with the JSR (Jet Side Release) series of buckles. Single bar tie-down for when space is a constraint.

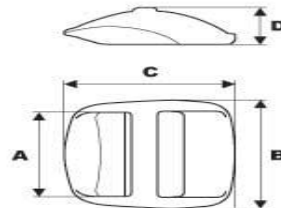

ITW Global	ITW FASTEX Australia	Webbing Size	Material	Colour	A	B	C	D
154-4025	386-1427	20mm / ¾"	Acetal	Black	25.9	33.6	30.5	11.5
154-4040	386-1428	40mm / 1½"	Acetal	Black	39.0	47.9	32.3	12.3



ITW Fastex General Products

2 – 4 Eskay Rd, South Oakleigh Vic. 3167, Australia

P.O. Box 172, Oakleigh MDC Vic. 3166, Australia

Telephone: (+61) 03 9570 2566 Fax: (+61) 03 9570 2780

E-mail: customer.service@fastex.com.au

CORD CLOSURES / BARRELOC

Along with the traditional Large and Small Barreloc, ITW Fastex General Products offers a "Toaster" Ellipse Barreloc. The Ellipse Barrelocs boast a patented hole alignment feature that eliminates the process of manually compressing the closure to thread the cord. Once the cord is easily threaded through the pre-aligned holes, a simple squeeze permanently unlocks the alignment mechanism and engages the spring to securely grip the cord.



ITW Global	ITW FASTEX Australia	Size	Material	Colour	Description
NZ	380-0359	6MM	Acetal	Black	Small
NZ	380-0096	6.5mm	Acetal	Black	Large
ITW Nexus	580-0034	5.0(h) x 8.0(w)mm	Acetal	Black	Ellipse
ITW Nexus	380-0760	5.0(h) x 8.0(w)mm	Acetal	Black	Toaster Ellipse



ITW Fastex General Products

2 – 4 Eskay Rd, South Oakleigh Vic. 3167, Australia

P.O. Box 172, Oakleigh MDC Vic. 3166, Australia

Telephone: (+61) 03 9570 2566 Fax: (+61) 03 9570 2780

E-mail: customer.service@fastex.com.au

SMALL SHOCK CORD HOOKS

Molded Shock Cord Fasteners are rust and corrosion proof, and since the entire unit is molded, the traditional metal crimp ring is eliminated. They securely grip shock cords by means of a patented fastening mechanism, and the slip ring conceals the end of the shock cord, giving it a clean finished appearance.

ITW Global	ITW FASTEX Australia	Size	Material	Colour
605-0250	380-1229	6.5mm	Nylon	Black



CARABINA SHOCK CORD HOOKS

The moulded Carabina or Shock Cord Hook & Bush is rust and corrosion proof and being a totally moulded unit, the traditional metal crimp ring is eliminated. The fastening method securely grips shock cord whilst the slip ring conceals the end of the shock cord providing a neat finish.

ITW New Zealand	ITW FASTEX Australia	Size	Material	Colour
NZ	380-0371	8mm	Nylon	Black



ROTARY SNAP HOOKS

ITW Global	ITW FASTEX Australia	Size	Material	Colour
OS	580-0005	25mm	Acetal	Black





ITW Fastex General Products

2 – 4 Eskay Rd, South Oakleigh Vic. 3167, Australia

P.O. Box 172, Oakleigh MDC Vic. 3166, Australia

Telephone: (+61) 03 9570 2566 Fax: (+61) 03 9570 2780

E-mail: customer.service@fastex.com.au

LOOPLOCS

Looplocs are ideal for holding straps or webbing where no adjustment is needed. Some versions are made of sewable plastic to simplify manufacturing.

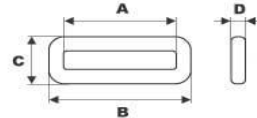

ITW Global	ITW FASTEX Australia	Webbing Size	Material	Colour	A	B	C	D
111-0075	386-0820	20mm / 3/4"	Acetal	Black	20.0	27.2	17.5	5.8
111-0100	386-0825	25mm / 1"	Acetal	Black	26.4	33.8	18.0	5.8
111-0150	386-0840	40mm / 1 1/2"	Acetal	Black	38.6	48.0	23.0	6.6
111-0200	386-0850	50mm / 2"	Acetal	Black	51.0	60.2	23.7	6.7

Mako Looploc

A redesigned Looploc that is available in both the 20mm and 25mm size. The Mako Looploc is lighter than a traditional Standard Looploc.

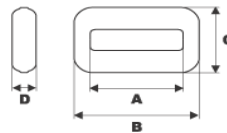

ITW Global	ITW FASTEX Australia	Webbing Size	Material	Colour	A	B	C	D
111-2020	386-0821	20mm / 3/4"	Acetal	Black	20.3	27.2	23.7	7.1
111-2025	386-0826	25mm / 1"	Acetal	Black	26.0	32.4	25.6	7.0



ITW Fastex General Products

2 – 4 Eskay Rd, South Oakleigh Vic. 3167, Australia

P.O. Box 172, Oakleigh MDC Vic. 3166, Australia

Telephone: (+61) 03 9570 2566 Fax: (+61) 03 9570 2780

E-mail: customer.service@fastex.com.au

D-RINGS

Utilising components from ITW Nexus & ITW Fastex we can offer a collection of loops and rings to provide a variety of webbing connection points

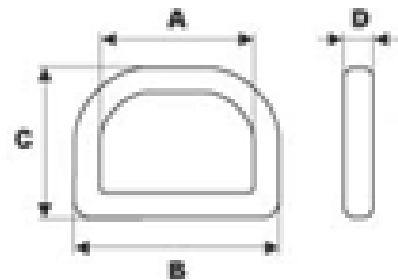

ITW Global	ITW FASTEX Australia	Webbing Size	Material	Colour	A	B	C	D
110-0075	Special	20mm / ¾"	Acetal	Black	21.7	31.8	27.7	5.4
110-0100	386-0625	25mm / 1"	Acetal	Black	25.8	38.8	27.6	5.7
110-0150	Special	40mm / 1½"	Acetal	Black	38.1	48.0	30.0	5.7
110-0200	Special	50mm / 2"	Acetal	Black	50.0	62.2	33.7	5.9



ITW Fastex General Products

2 – 4 Eskay Rd, South Oakleigh Vic. 3167, Australia

P.O. Box 172, Oakleigh MDC Vic. 3166, Australia

Telephone: (+61) 03 9570 2566 Fax: (+61) 03 9570 2780

E-mail: customer.service@fastex.com.au

SPECIALTY BUCKLES

The patented Lockable Side Release Buckle has been designed to offer the normal side release functionality with the added advantage of a key driven locking mechanism that restricts the ability to open the buckle.

The non-corrosive whistle provides an excellent safety device for a variety of outdoor activities. The high pitch sound is significantly louder than a conventional ball whistle and can be heard over long distances. These attributes have allowed ITW to obtain EN394 Approval for this product.

The LJ25 buckle has been developed to provide superior locking strength with anti-pinching characteristics, making this part an excellent choice for safety vests.



Lockable SR Buckle & Key



LJ 25



Whistle

ITW Global	ITW FASTEX Australia	Webbing Size	Material	Colour	Description	Type
Nexus	380-1100	25mm / 1"	Acetal	Black	Lockable	
Nexus	386-1101	25mm / 1"	Acetal	Black	Key	
NZ	386-1170 386-1169		Acetal	Orange Black	Whistle Whistle	
NZ	950-1195	25mm / 1"	Acetal	Black	Life Jacket	Single



ITW Fastex General Products

2 – 4 Eskay Rd, South Oakleigh Vic. 3167, Australia

P.O. Box 172, Oakleigh MDC Vic. 3166, Australia

Telephone: (+61) 03 9570 2566 Fax: (+61) 03 9570 2780

E-mail: customer.service@fastex.com.au

MILITARY BUCKLES

ITW Fastex has been supplying military style buckles and accessories for in excess of 15 years. Manufactured from a special toughened grade of Khaki coloured Nylon, the buckles are designed to provide maximum performance for applications where functionality is critical.



ITW New Zealand	ITW FASTEX Australia	Webbing Size	Material	Colour	Description	Type
NZ	380-0946	20mm / 3/4"	Nylon	Khaki	Classic	SR
NZ	380-0816	25mm / 1"	Nylon	Khaki	Classic	SR
NZ	380-0928	50mm / 2"	Nylon	Khaki	Classic	SR
NZ	380-0934	60mm / 2 1/2"	Nylon	Khaki	Classic	SR



ITW New Zealand	ITW FASTEX Australia	Webbing Size	Material	Colour	Description	Type
NZ	950-1232	25mm / 1"	Nylon	Khaki	Heavy Duty	SR

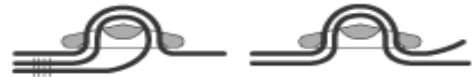

ITW New Zealand	ITW FASTEX Australia	Webbing Size	Material	Colour	Description
NZ	380-0289	25mm / 1"	Nylon	Khaki	Tri-Glide
NZ	380-0816	50mm / 2"	Nylon	Khaki	Tri-Glide



ITW Fastex General Products

2 – 4 Eskay Rd, South Oakleigh Vic. 3167, Australia

P.O. Box 172, Oakleigh MDC Vic. 3166, Australia

Telephone: (+61) 03 9570 2566 Fax: (+61) 03 9570 2780

E-mail: customer.service@fastex.com.au

MILITARY BUCKLES



ITW New Zealand	ITW FASTEX Australia	Webbing Size	Material	Colour	Description	Type
NZ	386-0064	25mm / 1"	Acetal	Khaki	Super	Ladderloc
NZ	386-0761	25mm / 1"	Acetal	Khaki	Trovato	Ladderloc



ITW New Zealand	ITW FASTEX Australia	Webbing Size	Material	Colour	Description	Type
NZ	386-0717	25mm / 1"	Nylon	Khaki	D-Ring	
NZ	380-0141		Acetal	Khaki	Barreloc	Large
NZ	386-1158	58mm	Nylon	Khaki	Icicle Clip	



Surmount



Tuck Buckle

ITW New Zealand	ITW FASTEX Australia	Webbing Size	Material	Colour	Description	Type
NZ	380-1196	25mm / 1"	Nylon	Khaki	Tuck Buckle	3 Pc
NZ	386-1325	25mm / 1"	Ghillietex	Tan	Surmount	Body
NZ	386-1326	25mm / 1"	Ghillietex	Tan	Surmount	Latch
NZ	386-1327	25mm / 1"	Ghillietex	Tan	Surmount	B-Plate